

Installation of carpet tiles

modulyss® carpet tiles are available in different colours, structures and designs. The creative possibilities are consequently limitless. For optimal results, however, a correct installation of the carpet tiles is an absolute must. So follow the installation instructions carefully.

One of the most important advantages of modulyss® carpet tiles is the ease and flexibility with which they can be installed or replaced. Installing carpet tiles moreover means savings in costs thanks to the smaller cutting loss by comparison with fitted carpets or other floor covering.

01 Preparation

Packaging

A pallet comprises 20 cases. Each case contains 5 m² of carpet tiles.

Place the cases on a flat surface in the room where the carpet is to be installed. Open the cases on the top or on the side and leave the tiles for at least 24 hours to get acclimatised.

Inspection

The quality, colour and batch number are mentioned on each case. This information, together with the arrow that indicates the pile direction can be found on the backside of each carpet tile. For an even result, it is very important to use tiles from the same batch in one and the same room. You must therefore always check the material delivered before proceeding to install the tiles.

Environmental conditions

Whilst waiting to install them, store the tiles in a closed room where the temperature is between 15°C and 25°C and the relative humidity \pm 60 %.

Substrate

modulyss® carpet tiles can be installed on every floor provided that it is dry, clean, greaseproof, sturdy and even. Residues of previous floor covering must be removed.

The substrate must be stabilised and dry and must comply with the requirements of the national construction standards and requirements. The temperature of the substrate must be between 10°C and 25°C, and the humidity may not exceed 5%.

Underfloor heating

In a room with underfloor heating, the underfloor heating system must be switched off at least 24 hours before the carpet is installed. It can then be gradually brought back up to temperature ($\pm 5^\circ \text{C}/\text{day}$), 48 hours after the carpet tiles are installed. Make sure that the heating circuit is completely waterproof.

02 Installation of the carpet tiles

Installation

All carpet tiles are made so as to be installed separately.

No permanent gluing is needed to install the carpet tiles, so we recommend that an anti-slip or semi-permanent glue be used. These types of glue have a lasting, non-hardening adhesive effect once they dry.

Make sure that the carpet tiles are installed tightly against each other; the backing must fit closely and the piles may not be squeezed. If the carpet tiles are pressed too tightly, lumps and warps can occur.

It is best to start from the door opening when installing the floor. A complete tile is installed at the door opening, continuing further until the middle of the room, in parallel with the main wall. This midpoint serves as the point of departure for the subsequent step-by-step installation of the tiles.

Pile direction

An arrow on the backside of the tile indicates the pile direction, and can be used to install the product in different ways:

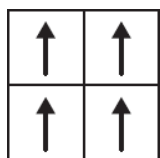

One way

The carpet tiles are installed in the same direction to create a uniform floor covering

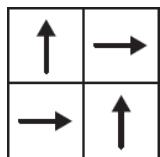

Draughtboard

The arrow on the back side of the carpet tiles is alternately turned 90°

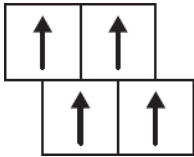

Half brick

Each tile is horizontally shifted half a row so that 4 corner points never coincide.

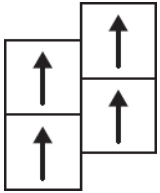

Ashlar

Each tile is horizontally shifted half a row so that 4 corner points never coincide.

The technical data sheet indicates which installation possibilities apply for the product concerned.

Cutting the tiles

To finish the room, the carpet tiles will in most cases have to be cut to measure by means of a Stanley cutter knife. Carpet tiles are cut on the backing.

Place Tile B to be cut precisely on Tile A. Use an extra tile (C).

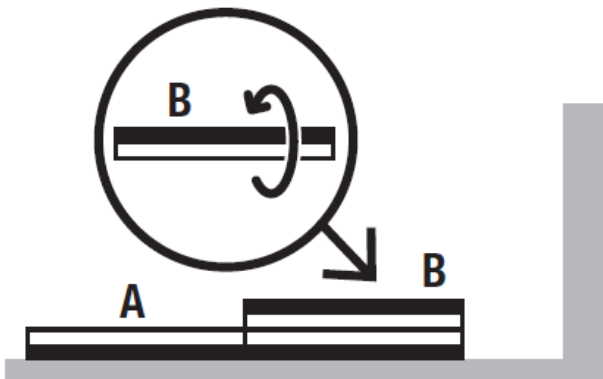

Push the latter up to the wall over Tile B.

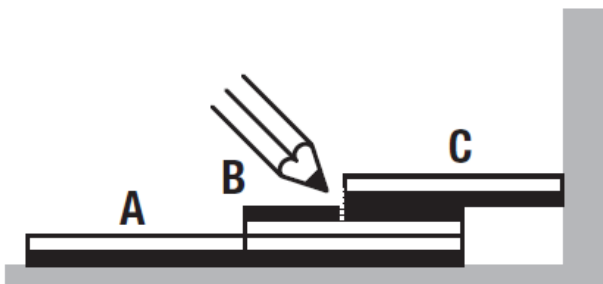

Now indicate on Tile B where you have to cut. Finally, install the cut Tile B in the space between the wall and Tile A.

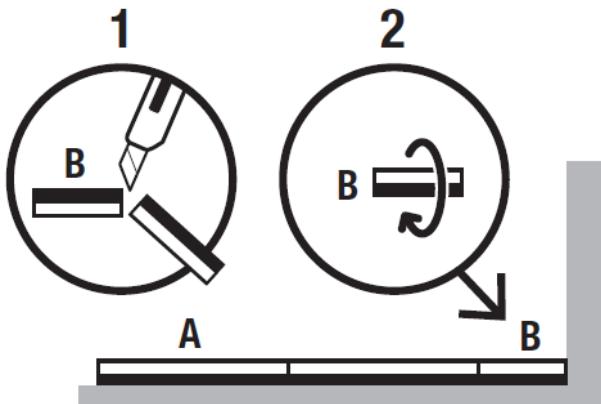

Floor protection after installation

Make sure that the floor covering just installed is sufficiently protected if the room still has to be used by other workers. So do not place any furniture on the floor during the installation. Move heavy furniture on hardboard plates to prevent the carpet from getting damaged.

03 Conditions

A maximum of 100 m² can be installed in advance for each installation for assessment purposes. If a party concerned should report any deviation from the original specifications and/or a production error is detected, modulyss® must be informed before proceeding with the further installation of the carpet tiles.

The modulyss® guarantee may no longer apply if the installation instructions are not followed. modulyss® shall not be held liable for errors resulting from unprofessional installation. The guarantee shall apply only if the carpet is used under normal circumstances (correct installation and maintenance).